





CONDOR PIT-STOP / TRAILER-STOP TRAILER ADAPTOR KIT INSTRUCTION MANUAL

STOP! WARNING: READ THIS FIRST!

First Read and Understand the Instruction manual and product labels for important safety, set-up and troubleshooting information. If you have problems setting up or using the Condor™ Pit-Stop, contact customer service @ 1-630-497-1962 or contact us via e-mail @ www.condor-lift.com. Condor™ Pit-Stop is not intended for use by children.

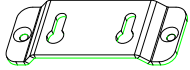
Assembly Instructions: Remove all parts from shipping box. Check the parts below to make sure you have all the parts needed to assemble your Condor™ Pit-Stop before beginning. In the unlikely event that you find a part damaged or missing, please call customer service @ #815-754-5418.

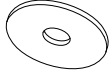
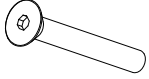
Condor Pit-Stop Parts Packing list:

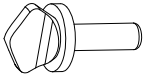
PICTURES OF PARTS	KEY	QUANTITY	PART DESCRIPTION
	J	1	Trailer Bracket
	K	2	Socket Shoulder Screw-3/8x3/8 Thread-5/16-18
	O	2	Large Washer (Fender Washer 5/16 x 1.25)
	P	2	Flat Head Socket Cap Screw 82i 5/16-18 X 2-1/2
	Q	2	Lock Nut 5/16-18
	R	1	Spade Head w/shoulder thumb Screw (5/16-18 x 1.0)

User Instructions:

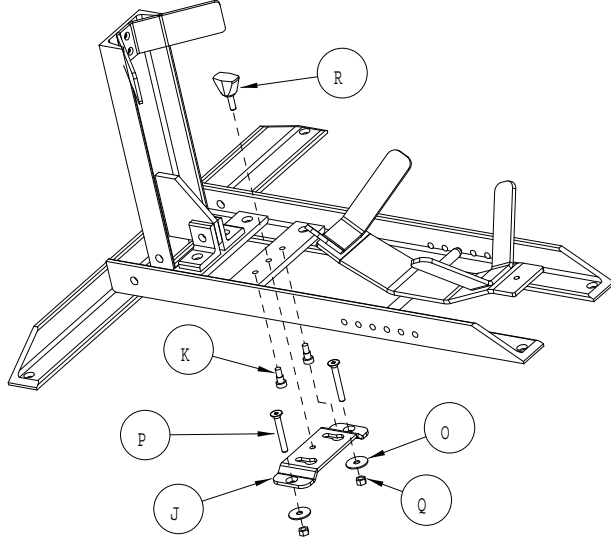

Step1: Attach parts K to the Condor Pit-Stop/Trailer-Stop cross bracket as shown. (Torque parts K to 18 ft-lbs)

Step2: Attach part J to mounting platform first. Allow a minimum of 10.0" of space on the mounting surface from the center of the trailer bracket J to the locked end of the Condor Pit-Stop/Trailer-Stop. The Condor unit should always be fully planted on the mounting platform when engaged into the trailer bracket J. Place part J parallel to platform end using the recommended dimension and drill holes for part P using a 5/16 drill bit.

Step3: Once the holes for part J are drilled, secure it using parts P, O and Q. Run Part P through part J and through mounting platform. Once part P has passed through the mounting platform, secure it with parts O and Q. Make sure that parts O and Q are secured as shown. Torque Q to 18-24 ft-lbs.

Step4: As shown, place Condor unit into Trailer bracket by inserting parts K into part J key way. Once parts K have entered the keyway of part K, slide the Condor unit forward and in the direction of the keyway path. Unit must slide in smoothly. If unit does not slide easily, use included washers under parts K to increase clearance to compensate for floor flatness. Once unit is locked into part J, proceed to use part R to secure and lock unit in place.

Caution: Always make sure that all fasteners are tight and all pins and parts are in place prior to use.

Warning: Only use Condor unit when trailer adapter kit is properly installed.

One Year Limited Warranty:

This Condor™ Pit-Stop product warranty extends to the original consumer purchaser of the product. All illustrations and specifications contained in this manual are based on the latest product information available at the time of printing. Technical Components Development & Design, Inc. reserves the right to make changes at any time, without notice, in color, materials, equipment, options, specifications and models. Models may be shown with optional equipment. Further information may be obtained by contacting Technical Components Development & Design, Inc. @ #815-754-7418

Warranty Duration:

This product is warranted to the original consumer purchase for a period of one (1) Year from original purchase date.

What is not covered:

Our warranty for your product will not cover abnormal wear of parts, damage resulting from negligent use or misuse of the product, use contrary to operating instructions, or disassembly, repair or alteration by any person other than an authorized service station. We shall not be liable for any incidental or consequential damages for breach of by express or implied warranty on your product.

How your state's law may apply:

Some states do not allow limitations on how long any implied warranty lasts or the exclusion or limitation of incidental or consequential damages. So the above limitation may not apply to you. This warranty gives you specific legal rights, and you may also have other rights, which may vary from state to state.

Thank you for purchasing the Condor Pit-Stop/Trailer-Stop Trailer Adapter Kit.

Condor™ is a trademark of Technical Components Development & Design, Inc.
The Condor Pit-Stop / Trailer-Stop is US Patented & International Patent Pending.

Made in the U.S.A.

4124 Stephenie Drive.
Cortland, IL 60112
Phone: (815) 754-7418
Fax: (815) 754-7419
Email: TCDD@condor-lift.com
WebSite: www.condor-lift.com

